

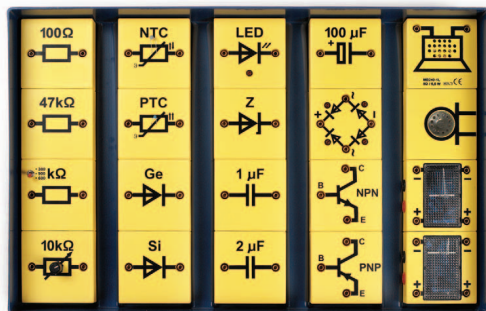

compact system demo
magnetostatics, electricity, electronics

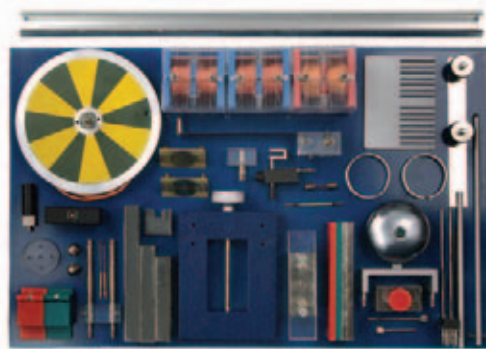
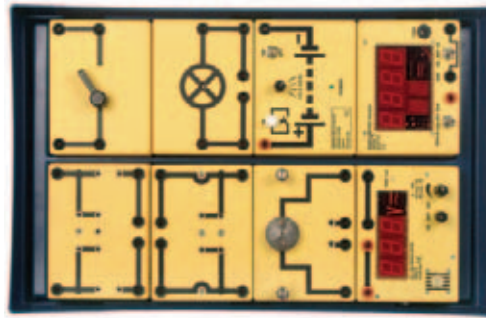

Demo equipment system

compact system demo

magnetostatics, electricity, electronics

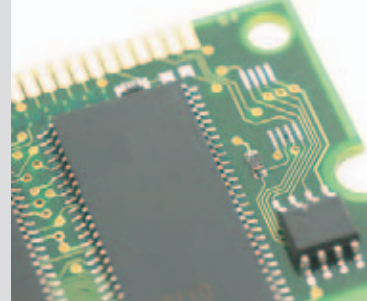

Electricity 1: compact system demo

DP800-1D Electricity 1 cs-D

consisting of:

- | | |
|------------|--|
| 1 DE820-2S | 1 MBCD Wire, interrupted |
| 2 DE820-3S | 1 MBCD Wire |
| 3 DE820-2T | 1 MBCD On-Off switch |
| 4 DE820-3A | 1 MBCD Light bulb socket, E10 |
| 5 DE820-2M | 1 MBCD Electromotor
input voltage: 0...9 V DC |
| P7810-1E | 1 Box insert MBI |
| P7806-1B | 1 Storage box, large, fitted
for equipment |

Recommended supplements to DP800-1D

- | | |
|------------|--|
| 6 P3122-4B | 1 Variable battery
The battery, equipped with four 1.5-volt D-size batteries, may be set to deliver 1.5, 3, 4.5 or 6 volts of fixed direct current. See under P3120-4B for further technical details. |
| 7 P3126-2W | 1 AC/DC regulator, "compact" with large digital display. See under P3125-2W for further technical details. |
| 8 DP722-1P | 1 Panelmeter "compact" Demonstration instrument for measuring current and voltage. See under DE722-1P for technical details. |

All of the parts listed above fit into storage box DP800-1D.

Required accessories:

- | | |
|----------|---|
| P3130-2P | 1 Fixed voltage transformer
12V DC/5.8A |
| DP130-2A | 1 Adapter cable |
| DP310-3E | 2 Connecting leads,
4-mm plug /
4-mm jack |
| P3711-1V | 1 Safety leads, set of 6 |

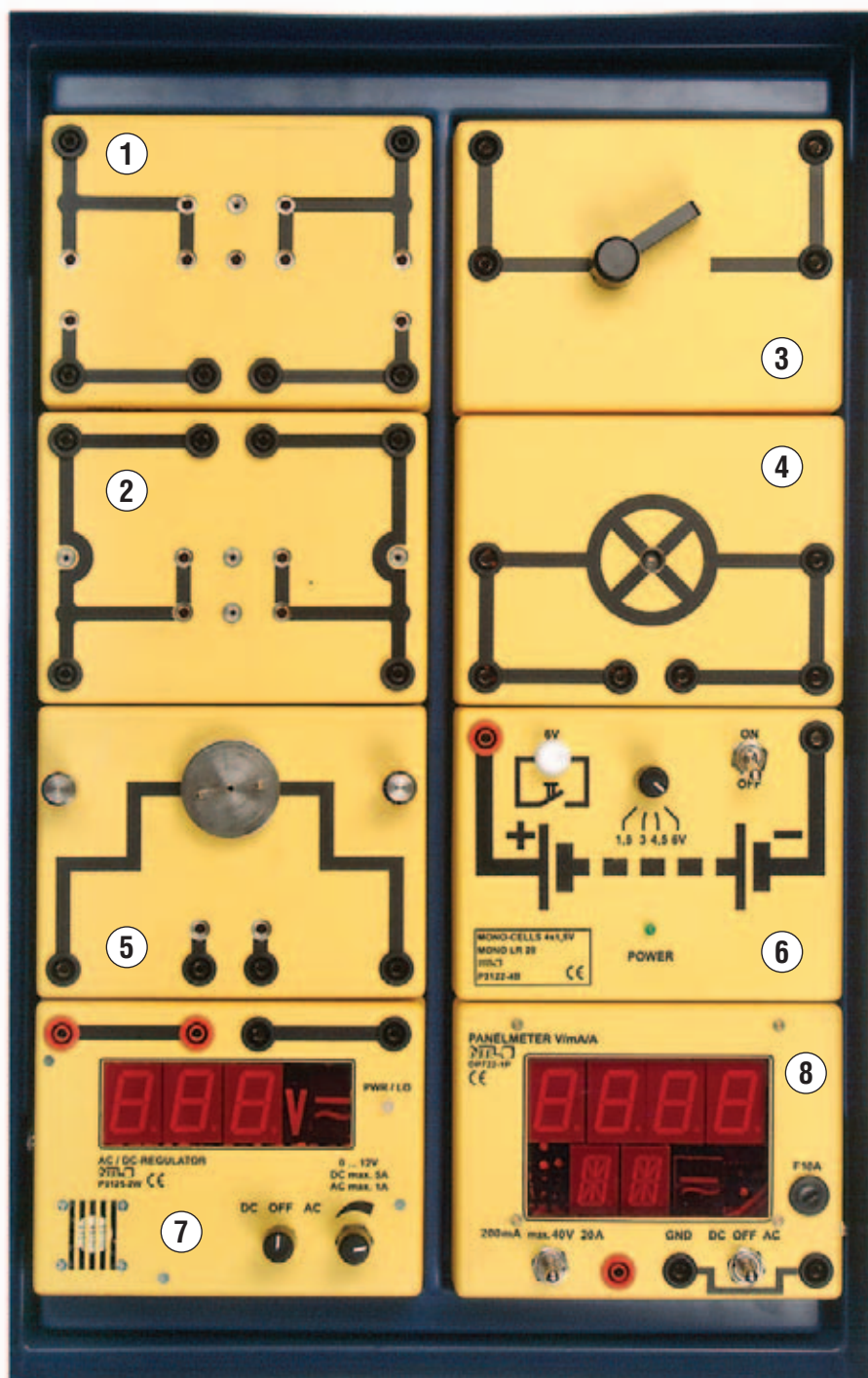



compact system demo magnetostatics, electricity, electronics

Magnetostatics & electricity: compact system demo

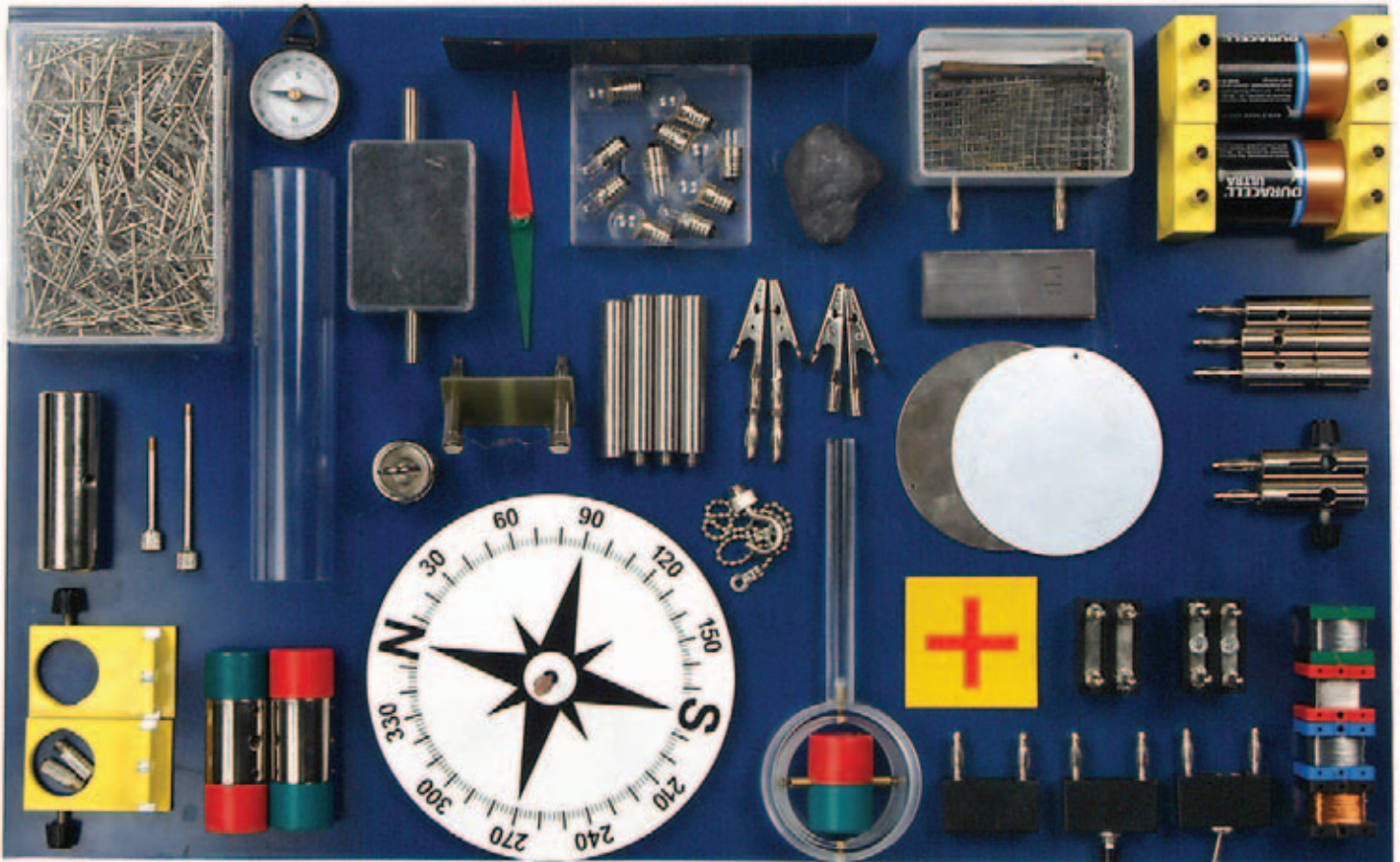

DP800-2D Magnetostatics & electricity cs-D consisting of:

Magnetostatics

DE400-1E	1	Magnetic ironstone
DE300-1N	1	Bearing pin on base
DE420-2W	1	Compass rose
P3410-5M	1	Pocket compass
DE420-1P	1	Magnetic needle with agate bearing, L=100 mm
P3411-1D	1	Magnetic field sensor, demo
DP410-1R	1	Bar magnets, cylindrical, pair
P3410-2B	2	Bearing sleeves
DP410-2R	1	Magnet holders, pair
DP711-1F	1	Fixing screw, short
DP711-2F	1	Fixing screw, long
DP410-6E	1	Iron core, cylindrical
DP410-2P	1	Tube for floating magnets
DE431-4S	1	Threaded rods, set of 4
DP410-1N	1	Iron nails, box
DE454-5F	1	Free-fall body
DS102-3S	2	C-hooks, threaded
DS412-2K	1	Bead chain, short
DE432-1E	1	Shield plate, iron
DE432-2A	1	Shield plate, aluminium

Electricity

P3310-1A	2	Crocodile clips, plain metal
P3911-3D	2	Crocodile clips with plug
DE921-3A	2	Holder with plug pin
P3712-1S	2	Jumper plugs, "compact", black
P3712-2S	3	Jumper plugs with connector terminal, black
P3713-3P	1	Toggle switch, "cs"
P3713-4P	1	Push button, "cs"
P3712-2E	1	Light bulb socket, E10, "cs"
DP911-2A	2	Connector terminals, pair
DG130-3B	2	Batteries, D-size, 1.5 V
P3325-2C	1	Electrolysis tank
P3325-2A	1	Electrodes, set
DE922-1D	1	Platform with plug pins
P3711-4K	3	Clamping sockets with plug
P3325-1A	1	Conductors and non-conductors, set of 7
DP711-1H	1	Heating element
P3711-5A	1	Carbon granule microphone, "compact" model
DP711-5B	1	Loudspeaker membrane, model
DP911-2S	1	"Plus", "Minus" signs, magnetic
P7812-3D	1	Box insert for magnetism, fitted to apparatus
P7806-1B	1	Storage box, large

compact system demo magnetostatics, electricity, electronics

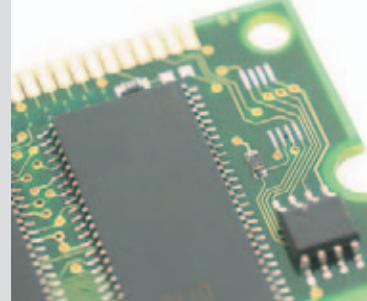

DP800-2V Supply items for DP800-2D

consisting of:

- DE309-1S 1 Light bulbs, 4 V/40 mA, E10, set of 5
- DE309-3S 1 Light bulb, 6 V/0.5 A, E10, set of 5
- DE309-4S 1 Light bulbs, 6 V/1 A, E10, set of 5



Experiment 001: A magnet used as a compass

- P3316-1Z 2 Wire meshes, I-shaped

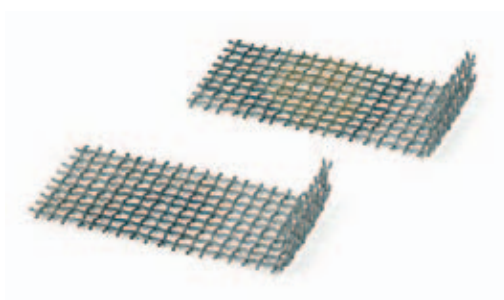

- P3314-1A 1 Fuse wire, D=0.1 mm, L=50 m
- P3316-1B 1 Copper wire, D = 0.2 mm, roll, black
- P3316-1C 1 Constantan wire, D = 0.2 mm, roll, blue
- P3316-1E 1 Iron wire, D = 0.2 mm, roll, green



- P3316-1M 1 Metal band, L = 1.6 m



- P1810-3B 1 Elastic string, white, L = 1 m



All of the parts fit into cs demo 3 storage box
DP800-2D magnetostatics & electricity cs-D



Experiment 013: Magnetic field of a bar magnet

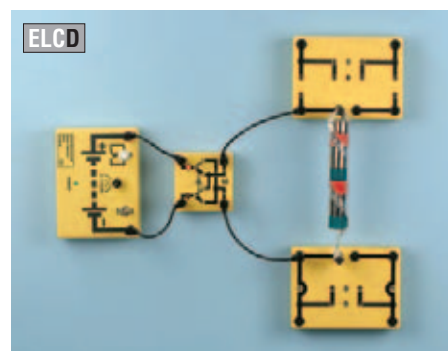

Experiment 065: Force caused by a flexible current-carrying conductor within the inhomogeneous magnetic field of a bar magnet

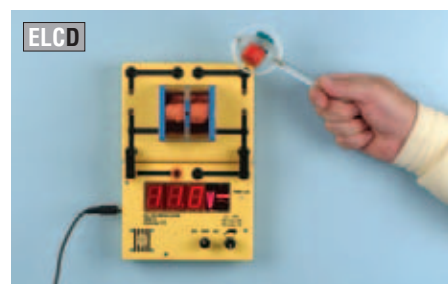

Experiment 066: Magnetic field of a current-carrying coil



compact system demo magnetostatics, electricity, electronics

Electromagnetism: compact system demo

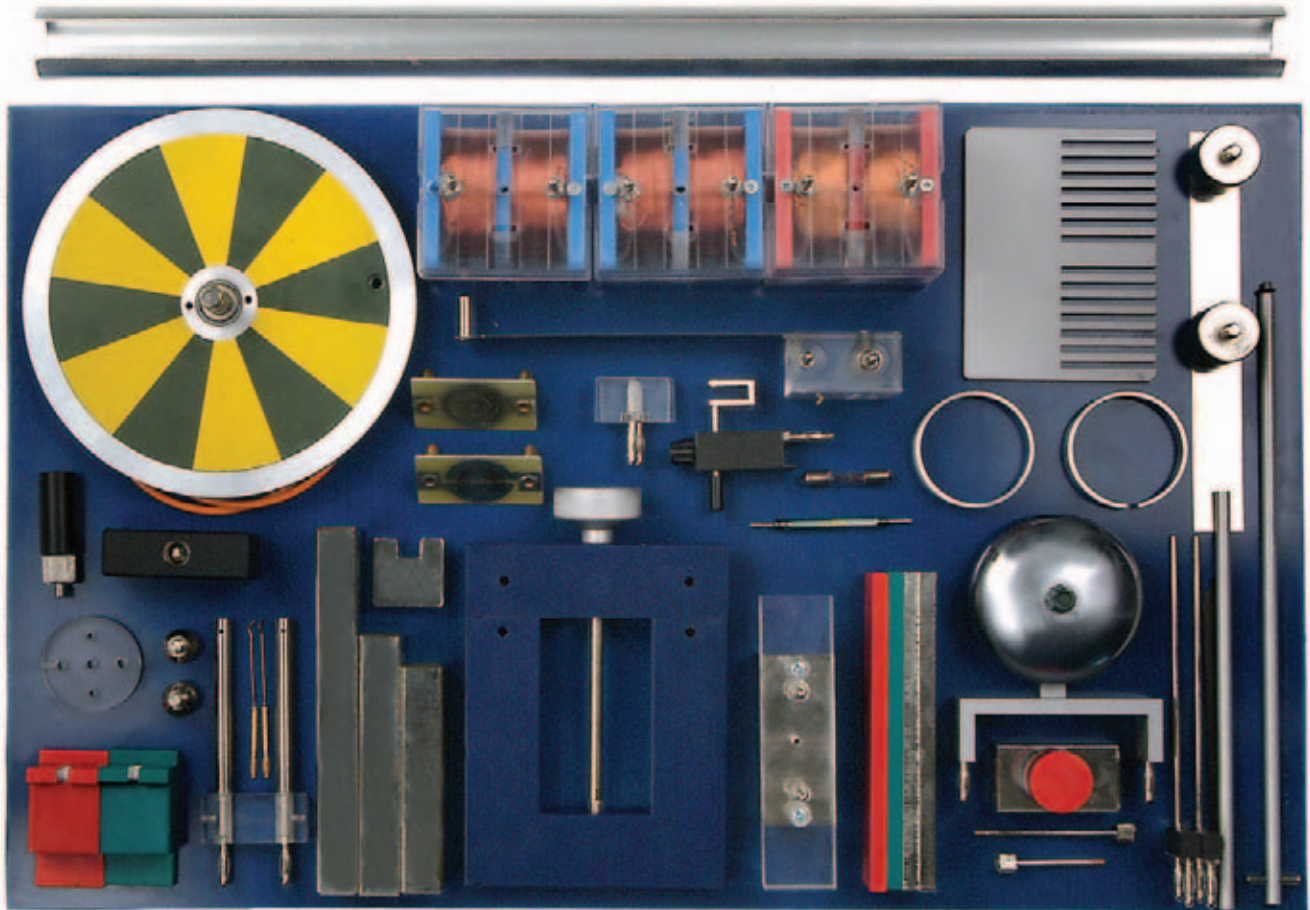

DP800-3D Elektromagnetism cs-D consisting of:

DP911-2R	2	Plug-in coils, 800 turns, blue	DE454-5A	1	Eddy current tube, slotted
DP911-3R	1	Plug-in coil, 1600 turns, red	DP711-1N	1	Brush holder
DE921-1D	1	U-shaped core with yoke, narrow	DP711-1P	2	Wire brushes
DE454-1F	2	Flat plugs	DP911-10	1	Commutator disc
DP410-6F	1	Iron core, solid, short	DP911-1R	1	Slip ring disc
DP410-6G	1	Iron core, solid, L=92 mm	DP711-1X	1	Pendulum rod
DP410-6H	1	Iron core, solid, L=105 mm	DE450-3S	1	Eddy current (Waltenhof) pendulum plate
DP410-6L	1	Iron core, solid, long	DP451-20	1	Aluminium ring, slotted
DP410-6S	1	Iron core, solid, with plug	DP451-2G	1	Aluminium ring
DP412-1T	1	Magnet holder for block magnets, red-green	DP451-1B	1	Bimetallic strip
DE412-1B	1	Block magnets, pair	DE451-3B	1	Aluminium rod, L=170 mm
DP410-2M	1	Plate holders for block magnets	DE451-2L	2	Rolling bridges with plug
DP410-4S	1	Spacing disc	DP407-2Z	1	Pointer, black
DS403-3F	2	Fixing screws M6	DE451-1R	1	Reed relay
DP711-1L	1	Pole plates, plain metal, pair	P3320-9B	1	Tubular fluorescent lamp
DP711-2R	1	Pole plates, red-green	DP407-1H	2	Adhesive magnets, threaded, for u-magnets
DE451-1K	1	Striker with plug	DP712-1E	1	Light bulb socket, E10
DP711-3E	1	Angular contact	DP402-3G	1	Drive pulley with tapped hole
DE451-1S	1	Bell gong, mounted	DS401-1A	1	Drive belts, set of 2
DP711-1F	1	Fixing screw, short	DS402-2N	1	Crank pin, L=50 mm
DP711-2F	1	Fixing screw, long	P7812-4D	1	Box insert for induction, MBCD, fitted to apparatus
DE407-1C	1	Round magnets, pair, 25x12 mm, neodymium	P7806-1B	1	Storage box, large

compact system demo magnetostatics, electricity, electronics

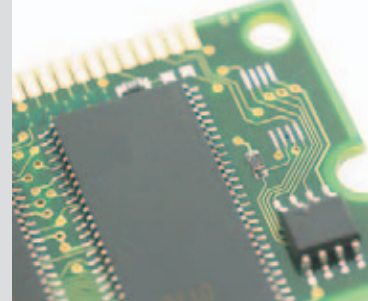

Electricity & electronics: compact system demo

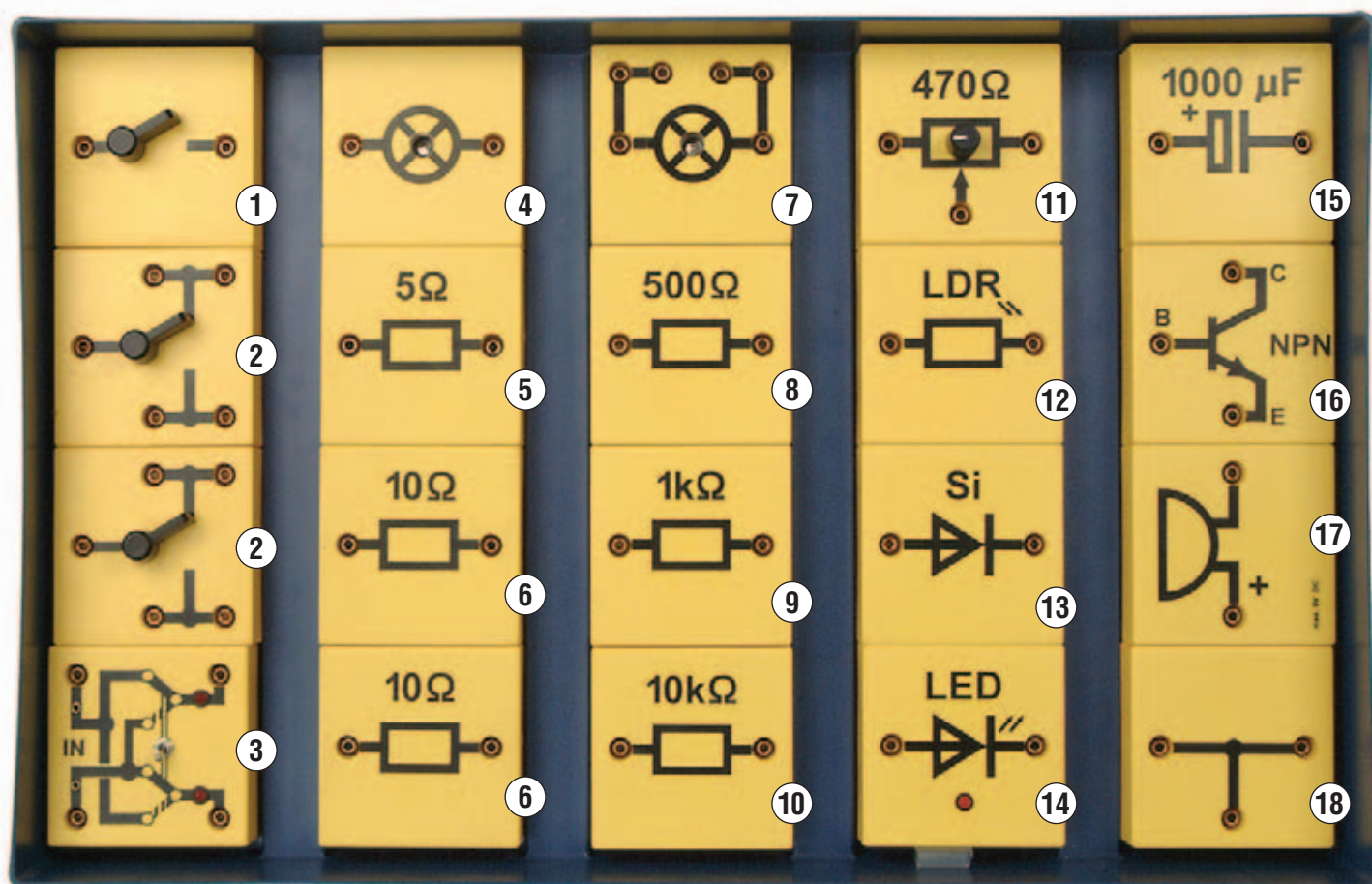

DP800-4D Electricity & electronics cs-D consisting of:

1	P3710-2R	1	MBC On-Off switch	11	P3710-5F	1	MBC Potentiometer 470 ohms, 4 W
2	P3710-2T	2	MBC Double-throw switches	12	P3710-4J	1	MBC Photo resistor (LDR)
3	P3710-2X	1	MBC Four-way switch	13	P3710-7A	1	MBC Si diode
4	P3710-2A	1	MBC Lamp socket E10, 2 jacks	14	P3710-7K	1	MBC LED, red
5	MB200-1W	1	MBC Precision resistor, 5 ohms	15	P3710-6R	1	MBC Capacitor 1000 μF
6	MB200-2W	2	MBC Precision resistors, 10 ohms	16	P3710-8A	1	MBC Transistor NPN, base left
7	P3710-2B	1	MBC Lamp socket E10, 6 jacks	17	P3711-2A	1	MBC Buzzer
8	P3710-3M	1	MBC Resistor 500 ohms	18	P3710-1T	1	MBC lead, t-shaped
9	P3710-3O	1	MBC Resistor 1 kOhm		P7806-1F	1	Storage box for MBCs, large, fitted for equipment
10	P3710-3R	1	MBC Resistor 10 kOhms				



compact system demo magnetostatics, electricity, electronics

Electricity & electronics supplement compact system demo

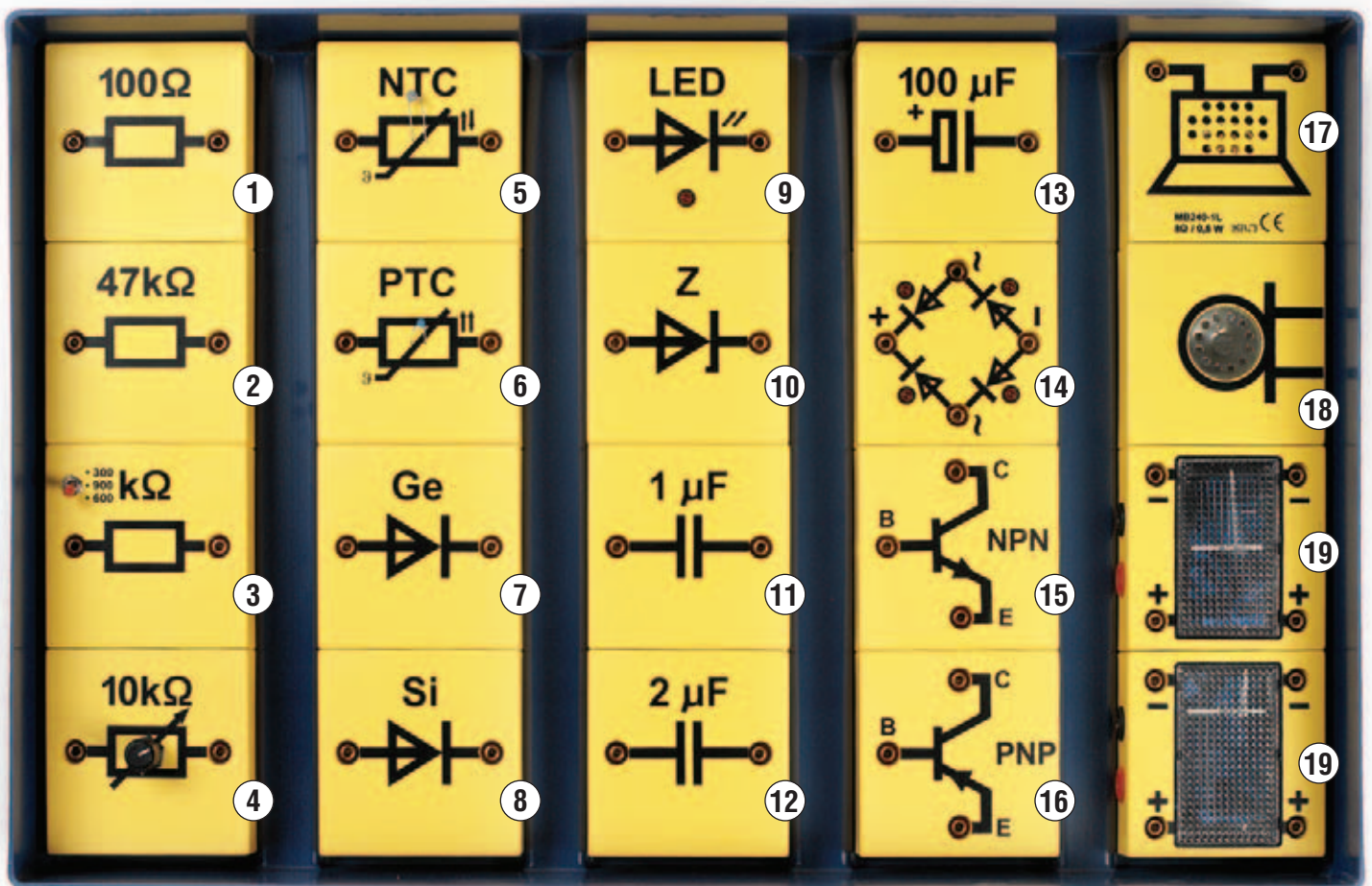

DP800-5D Electricity & electronics cs-D supplement consisting of:

1	P3710-3G	1	MBC Resistor 100 ohms	12	P3710-6H	1	MBC Capacitor 2 μF
2	P3710-3S	1	MBC Resistor 47 kOhms	13	P3710-6N	1	MBC Capacitor 100 μF
3	P3710-3K	1	MBC Resistance decade 300, 600, 900 kOhms	14	P3710-7T	1	MBC Bridge rectifier
4	P3710-5A	1	MBC Variable resistor 10 kOhms, 4 W	15	P3710-8A	1	MBC Transistor NPN, base left
5	P3710-4A	1	MBC NTC thermistor	16	P3710-8C	1	MBC Transistor PNP
6	P3710-4E	1	MBC PTC thermistor	17	MB240-1L	1	MBC Loudspeaker
7	P3710-8G	1	MBC Ge diode	18	P3721-2C	1	MBC Microphone
8	P3710-7A	1	MBC Si diode	19	MB210-1S	2	Solar cells, "compact"
9	P3710-7K	1	MBC LED, red		P7806-1F	1	Storage box for MBCs, large, fitted for equipment
10	P3710-7E	1	MBC Zener diode				
11	P3710-6G	1	MBC Capacitor 1 μF				